



● PRODUCT CATALOG

# INGROUND UPLIGHT & UNDERWATER LIGHT

VERSION 1 | 2024



[www.artisanlighting.net](http://www.artisanlighting.net)



# INGROUND & UPLIGHT

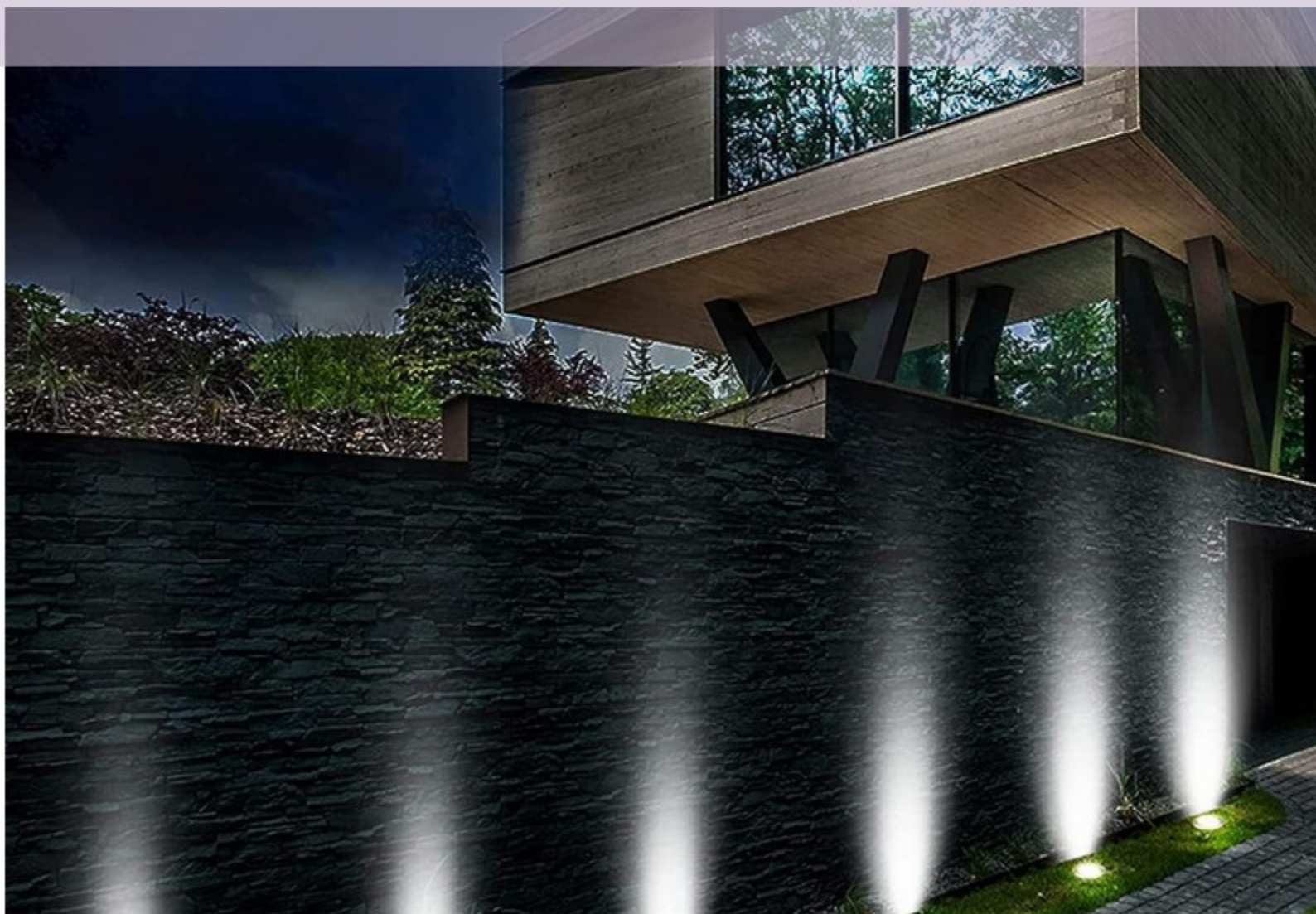

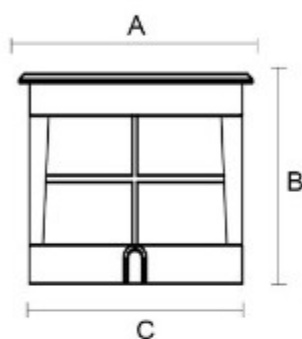

## IN-346-IB23-0501

### Product Description

Simple and easy appearance, in line with contemporary aesthetic concept

The lamp body adopts high quality and Anti-UV ability outdoor's polycarbonate;

High efficiency constant current driver, ensure the light source is maximum used.

**Protection class** : IP67

### Material

Diffuse : Glass

Body : Aluminum+Stainless steel

### Cut Out

095\*75mm/0115\*89mm/0145\*89mm

0155\*89mm/0185\*89mm/0235\*89mm/0293\*89mm

Item No.	Lamp Type	Power	LM	CCT	PF	Voltage	CRI	A	B	C (mm)
MB23-0501100	LED	6W	480	2700K-6000K	0.6	AC110-265V	80-90	Ø100	78	Ø95
MB23-0501120	LED	12W	960	2700K-6000K	0.6	AC110-265V	80-90	Ø120	92	Ø115
MB23-0501160	LED	18W	1440	2700K-6000K	0.6	AC110-265V	80-90	Ø160	92	Ø145
MB23-0501180	LED	24W	1920	2700K-6000K	0.9	AC110-265V	80-90	Ø180	92	Ø155
MB23-0501200	LED	36W	2880	2700K-6000K	0.9	AC110-265V	80-90	Ø200	92	Ø185
MB23-0501250	LED	48W	3840	2700K-6000K	0.9	AC110-265V	80-90	Ø250	92	Ø235
MB23-0501320	LED	72W	5760	2700K-6000K	0.9	AC110-265V	80-90	Ø320	92	Ø293

### IN-346-MB23-0502

#### Product Description

Simple and easy appearance, in line with contemporary aesthetic concept. The lamp body adopts high quality and Anti-UV ability outdoor's polycarbonate; High efficiency constant current driver, ensure the light source is maximum used.

**Protection class** : IP67

#### Material

Diffuse : Glass

Body : Aluminum+Stainless steel

#### Cut Out

0115\*135mm/0144\*150mm/0170\*163mm/0242\*190mm

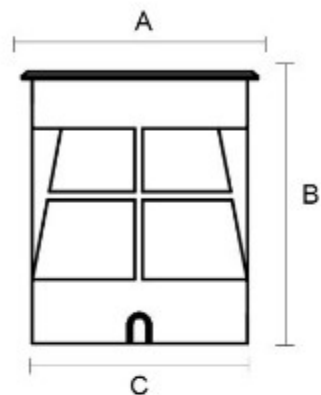

Item No.	Lamp Type	Power	LM	CCT	PF	Voltage	CRI	A	B	C (mm)
MB23-0502130	LED	6W	480	2700K-6000K	0.6	AC110-265V	80-90	Ø130	140	Ø115
MB23-0502160	LED	18W	1440	2700K-6000K	0.6	AC110-265V	80-90	Ø160	153	Ø144
MB23-0502200	LED	24W	1920	2700K-6000K	0.9	AC110-265V	80-90	Ø200	163	Ø170
MB23-0502250	LED	36W	2880	2700K-6000K	0.9	AC110-265V	80-90	Ø250	193	Ø242





### IN-346-MB23-0503

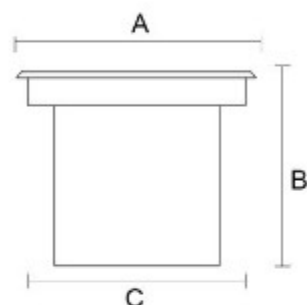

#### Product Description

Simple and easy appearance, in line with contemporary aesthetic concept

The lamp body adopts high quality and Anti-UV ability outdoor's polycarbonate;

High efficiency constant current driver, ensure the light source is maximum used.

**Protection class** : IP65

#### Material

Diffuse : Glass

Body : Aluminum+Stainless steel

#### Cut Out

Ø60\*70mm/075\*70mm/095\*80mm/115\*90mm/125\*90mm

Ø155\*90mm/Ø165\*90mm/Ø185\*90mm/Ø240\*90mm/Ø290\*90mm

Item No.	Lamp Type	Power	LM	CCT	PF	Voltage	CRI	A	B	C (mm)
MB23-050365	LED	1W	80	2700K-6000K	0.6	AC110-265V	80-90	Ø65	75	Ø60
MB23-050380	LED	3W	240	2700K-6000K	0.6	AC110-265V	80-90	Ø80	75	Ø75
MB23-0503100	LED	5W	400	2700K-6000K	0.6	AC110-265V	80-90	Ø100	85	Ø95
MB23-0503120	LED	6W	480	2700K-6000K	0.6	AC110-265V	80-90	Ø120	95	Ø115
MB23-0503150	LED	9W	720	2700K-6000K	0.6	AC110-265V	80-90	Ø150	95	Ø125
MB23-0503160	LED	12W	960	2700K-6000K	0.6	AC110-265V	80-90	Ø160	95	Ø155
MB23-0503180	LED	15W	1200	2700K-6000K	0.6	AC110-265V	80-90	Ø180	95	Ø165
MB23-0503200	LED	18W	1440	2700K-6000K	0.6	AC110-265V	80-90	Ø200	95	Ø185
MB23-0503250	LED	24W	1920	2700K-6000K	0.9	AC110-265V	80-90	Ø250	95	Ø240
MB23-0503300	LED	36W	2880	2700K-6000K	0.9	AC110-265V	80-90	Ø300	95	Ø290



### Product Description

Simple and easy appearance, in line with contemporary aesthetic concept. The lamp body adopts high quality and Anti-UV ability outdoor's polycarbonate; High efficiency constant current driver, ensure the light source is maximum used.

**Protection class** : IP65

### Material

Diffuse : Glass

Body : Aluminum+Stainless steel

### Cut Out

Ø60\*70mm/075\*70mm/095\*80mm/115\*90mm

Ø155\*90mm/0165\*90mm/185\*90mm/0206\*90mm/0240\*90mm

## IN-346-MB23-0504

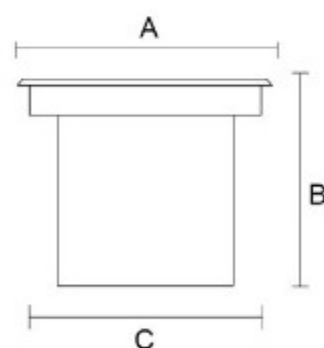

Item No.	Lamp Type	Power	LM	CCT	PF	Voltage	CRI	A	B	C (mm)
MB23-050465	LED	3W	240	2700K-6000K	0.6	AC110-265V	80-90	Ø65	75	Ø60
MB23-050480	LED	5W	400	2700K-6000K	0.6	AC110-265V	80-90	Ø80	75	Ø75
MB23-0504100	LED	7W	560	2700K-6000K	0.6	AC110-265V	80-90	Ø100	85	Ø95
MB23-0504120	LED	10W	800	2700K-6000K	0.6	AC110-265V	80-90	Ø120	95	Ø115
MB23-0504160	LED	15W	1200	2700K-6000K	0.9	AC110-265V	80-90	Ø160	95	Ø155
MB23-0504180	LED	20W	1600	2700K-6000K	0.9	AC110-265V	80-90	Ø180	95	Ø165
MB23-0504200	LED	30W	2400	2700K-6000K	0.9	AC110-265V	80-90	Ø200	95	Ø185
MB23-0504220	LED	40W	3200	2700K-6000K	0.9	AC110-265V	80-90	Ø220	95	Ø206
MB23-0504250	LED	50W	4000	2700K-6000K	0.9	AC110-265V	80-90	Ø250	95	Ø240



### IN-346-MB23-0505

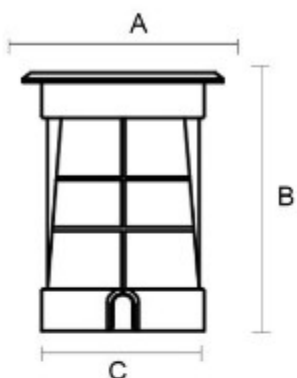

#### Product Description

Simple and easy appearance, in line with contemporary aesthetic concept

The lamp body adopts high quality and Anti-UV ability outdoor's polycarbonate;

High efficiency constant current driver, ensure the light source is maximum used.

**Protection class** : IP65

#### Material

Diffuse : Glass

Body : Aluminum+Stainless steel

#### Cut Out

Ø65\*92mm

Item No.	Lamp Type	Power	LM	CCT	PF	Voltage	CRI	A	B	C (mm)
MB23-0505	LED	5W	400	2700K-6000K	0.6	AC110-265V	80-90	Ø80	95	Ø65

#### Product Description

Simple and easy appearance, in line with contemporary aesthetic concept. The lamp body adopts high quality and Anti-UV ability outdoor's polycarbonate; High efficiency constant current driver, ensure the light source is maximum used.

**Protection class** : IP65

#### Material

Diffuse : Glass

Body : Stainless steel

#### Cut Out

Ø1734mm / Ø1736mm / Ø16.5\*55mm

Ø1330mm / Ø1227mm / Ø11\*35mm

### IN-346-MB23-0506



Item No.	Lamp Type	Power	LM	CCT	PF	Voltage	CRI	A	B	C (mm)
MB23-050625	LED	0.5W	40	2700K-6000K	0.6	AC110-265V	80-90	Ø25	34	Ø17
MB23-050623	LED	0.5W	40	2700K-6000K	0.6	AC110-265V	80-90	Ø23	36	Ø17
MB23-050622	LED	0.5W	40	2700K-6000K	0.6	AC110-265V	80-90	Ø22	55	Ø16.5
MB23-050620	LED	0.4W	32	2700K-6000K	0.6	AC110-265V	80-90	Ø20	30	Ø13
MB23-050615	LED	0.3W	24	2700K-6000K	0.6	AC110-265V	80-90	Ø15	27	Ø12
MB23-050612	LED	0.2W	16	2700K-6000K	0.6	AC110-265V	80-90	Ø12	35	Ø11



### IN-346-MB23-10132

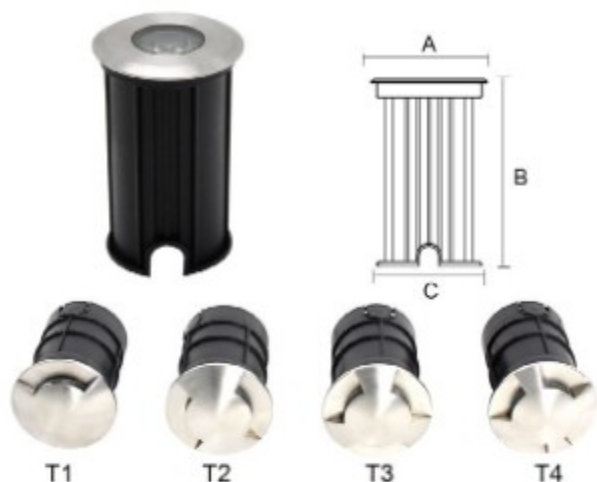

#### Product Description

Simple and easy appearance, in line with contemporary aesthetic concept

The lamp body adopts high quality and Anti-UV ability outdoor's polycarbonate;

High efficiency constant current driver, ensure the light source is maximum used.

**Protection class** : IP65

#### Material

Diffuse : Glass

Body : Stainless steel

#### Cut Out

Ø56\*86mm

Item No.	Lamp Type	Power	LM	CCT	PF	Voltage	CRI	A	B	C (mm)
MB-10132	LED	1W	80	2700K-6000K	0.6	AC110-265V	80-90	Ø62	90	Ø56
MB-10132T1	LED	1W	80	2700K-6000K	0.6	AC110-265V	80-90	Ø62	100	Ø56
MB-10132T2	LED	1W	80	2700K-6000K	0.6	AC110-265V	80-90	Ø62	100	Ø56
MB-10132T3	LED	1W	80	2700K-6000K	0.6	AC110-265V	80-90	Ø62	100	Ø56
MB-10132T4	LED	1W	80	2700K-6000K	0.6	AC110-265V	80-90	Ø62	100	Ø56

### IN-346-MB23-10133

#### Product Description

Simple and easy appearance, in line with contemporary aesthetic concept. The lamp body adopts high quality and Anti-UV ability outdoor's polycarbonate;

High efficiency constant current driver, ensure the light source is maximum used.

**Protection class** : IP65

#### Material

Diffuse : Glass

Body : Stainless steel

#### Cut Out

Ø47\*88mm



Item No.	Lamp Type	Power	LM	CCT	PF	Voltage	CRI	A	B	C (mm)
MB-10133	LED	1W	80	2700K-6000K	0.6	AC110-265V	80-90	Ø52	84	Ø47
MB-10133T1	LED	1W	80	2700K-6000K	0.6	AC110-265V	80-90	Ø52	93	Ø47
MB-10133T2	LED	1W	80	2700K-6000K	0.6	AC110-265V	80-90	Ø52	93	Ø47
MB-10133T3	LED	1W	80	2700K-6000K	0.6	AC110-265V	80-90	Ø52	93	Ø47
MB-10133T4	LED	1W	80	2700K-6000K	0.6	AC110-265V	80-90	Ø52	93	Ø47



## IN-346-MB23-10134

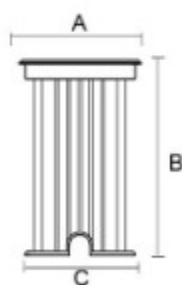

### Product Description

Simple and easy appearance, in line with contemporary aesthetic concept

The lamp body adopts high quality and Anti-UV ability outdoor's polycarbonate;

High efficiency constant current driver, ensure the light source is maximum used.

**Protection class** : IP65

### Material

Diffuse : Glass

Body : Stainless steel

### Cut Out

Ø38\*70mm

Item No.	Lamp Type	Power	LM	CCT	PF	Voltage	CRI	A	B	C (mm)
MB-10134	LED	1W	80	2700K-6000K	0.6	AC110-265V	80-90	Ø42	74	Ø38
MB-10134T1	LED	1W	80	2700K-6000K	0.6	AC110-265V	80-90	Ø42	82	Ø38
MB-10134T2	LED	1W	80	2700K-6000K	0.6	AC110-265V	80-90	Ø42	82	Ø38
MB-10134T3	LED	1W	80	2700K-6000K	0.6	AC110-265V	80-90	Ø42	82	Ø38
MB-10134T4	LED	1W	80	2700K-6000K	0.6	AC110-265V	80-90	Ø42	82	Ø38

## IN-346-MB-D001

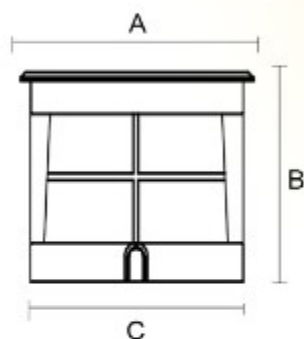

### Product Description

Simple and easy appearance, in line with contemporary aesthetic concept. The lamp body adopts high quality and Anti-UV ability outdoor's polycarbonate; High efficiency constant current driver, ensure the light source is maximum used.

**Protection class** : IP65

### Material

Diffuse : Glass

Body : Aluminum+Stainless steel

### Cut Out

Ø148\*118mm / Ø168\*118mm / Ø198\*118mm



Item No.	Lamp Type	Power	LM	CCT	PF	Voltage	CRI	A	B	C (mm)
MB-D001	LED	10W	80	2700K-6000K	0.6	AC110-265V	80-90	Ø150	120	Ø148
MB-D002	LED	15W	80	2700K-6000K	0.6	AC110-265V	80-90	Ø180	120	Ø168
MB-D003	LED	20W	80	2700K-6000K	0.9	AC110-265V	80-90	Ø210	120	Ø198

### IN-346-MB-D011

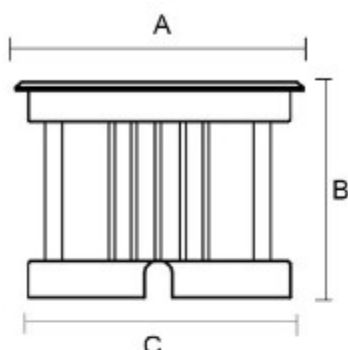

#### Product Description

Simple and easy appearance, in line with contemporary aesthetic concept

The lamp body adopts high quality and Anti-UV ability outdoor's polycarbonate;

High efficiency constant current driver, ensure the light source is maximum used.

**Protection class** : IP67

#### Material

Diffuse : Glass

Body : Stainless steel

#### Cut Out

Ø90\*72mm

Item No.	Lamp Type	Power	LM	CCT	PF	Voltage	CRI	A	B	C (mm)
MB-D011	LED	3W	240	2700K-6000K	0.6	AC110-265V	80-90	Ø100	75	Ø90

### IN-346-MB-D012

#### Product Description

Simple and easy appearance, in line with contemporary aesthetic concept. The lamp body adopts high quality and Anti-UV ability outdoor's polycarbonate;

High efficiency constant current driver, ensure the light source is maximum used.

**Protection class** : IP65

#### Material

Diffuse : Glass

Body : Aluminum+Stainless steel

#### Cut Out

Ø145\*100mm / Ø168\*118mm / Ø200\*118mm / Ø290\*102mm

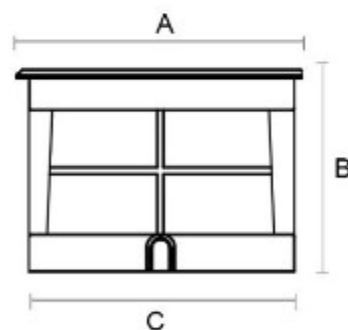

Item No.	Lamp Type	Power	LM	CCT	PF	Voltage	CRI	A	B	C (mm)
MB-D012	LED	9W	720	2700K-6000K	0.6	AC110-265V	80-90	Ø160	105	Ø145
MB-D013	LED	12W	960	2700K-6000K	0.6	AC110-265V	80-90	Ø180	118	Ø168
MB-D014	LED	18W	1440	2700K-6000K	0.6	AC110-265V	80-90	Ø210	118	Ø200
MB-D015	LED	24W	1920	2700K-6000K	0.9	AC110-265V	80-90	Ø260	118	Ø240
MB-D016	LED	36W	2880	2700K-6000K	0.9	AC110-265V	80-90	Ø320	105	Ø290

### IN-346-MB-D017

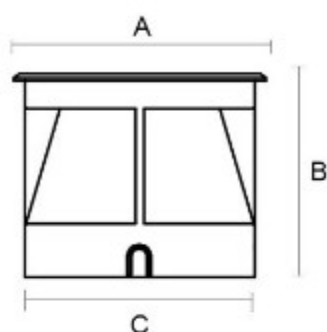

#### Product Description

Simple and easy appearance, in line with contemporary aesthetic concept

The lamp body adopts high quality and Anti-UV ability outdoor's polycarbonate;

High efficiency constant current driver, ensure the light source is maximum used.

**Protection class** : IP67

#### Material

Diffuse : Glass

Body : Aluminum+Stainless steel

#### Cut Out

Ø150\*140mm/Ø175\*125mm/Ø198\*140mm/Ø245\*140mm

Item No.	Lamp Type	Power	LM	CCT	PF	Voltage	CRI	A	B	C (mm)
MB-D017	LED	15W	1200	2700K-6000K	0.6	AC110-265V	80-90	Ø160	145	Ø150
MB-D018	LED	20W	1600	2700K-6000K	0.9	AC110-265V	80-90	Ø180	130	Ø175
MB-D019	LED	30W	2400	2700K-6000K	0.9	AC110-265V	80-90	Ø210	145	Ø198
MB-D020	LED	50W	4000	2700K-6000K	0.9	AC110-265V	80-90	Ø270	145	Ø245

### IN-346-MB-D021

#### Product Description

Simple and easy appearance, in line with contemporary aesthetic concept. The lamp body adopts high quality and Anti-UV ability outdoor's polycarbonate;

High efficiency constant current driver, ensure the light source is maximum used.

**Protection class** : IP65

#### Material

Diffuse : Glass

Body : Aluminum+Stainless steel

#### Cut Out

Ø125\*140mm

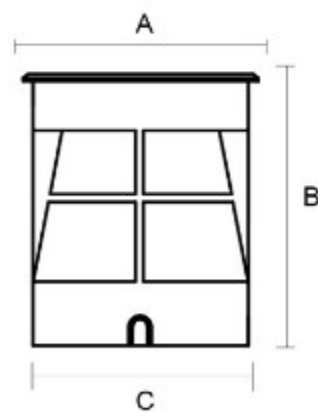

Item No.	Lamp Type	Power	LM	CCT	PF	Voltage	CRI	A	B	C (mm)
MB-D021	LED	7W	560	2700K-6000K	0.6	AC110-265V	80-90	Ø130	145	Ø125

## IN-346-MB-D022

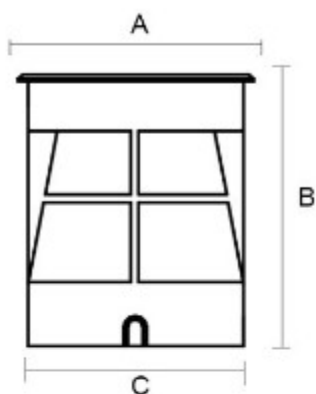

### Product Description

Simple and easy appearance, in line with contemporary aesthetic concept

The lamp body adopts high quality and Anti-UV ability outdoor's polycarbonate;

High efficiency constant current driver, ensure the light source is maximum used.

**Protection class** : IP67

### Material

Diffuse : Glass

Body : Aluminum+Stainless steel

### Cut Out

ø150\*180mm/ø170\*180mm

Item No.	Lamp Type	Power	LM	CCT	PF	Voltage	CRI	A	B	C (mm)
MB-D022	LED	15W	1200	2700K-6000K	0.6	AC110-265V	80-90	Ø160	185	Ø150
MB-D023	LED	20W	1600	2700K-6000K	0.9	AC110-265V	80-90	Ø180	185	Ø170



## IN-346-MB-D024

### Product Description

Simple and easy appearance, in line with contemporary aesthetic concept. The lamp body adopts high quality and Anti-UV ability outdoor's polycarbonate; High efficiency constant current driver, ensure the light source is maximum used.

**Protection class** : IP65

### Material

Diffuse : Glass

Body : Aluminum+Stainless steel

### Cut Out

ø92\*120mm

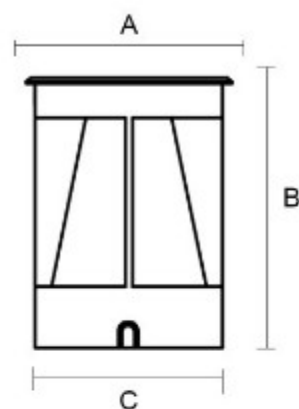

Item No.	Lamp Type	Power	LM	CCT	PF	Voltage	CRI	A	B	C (mm)
MB-D024	LED	3W	240	2700K-6000K	0.6	AC110-265V	80-90	Ø100	125	Ø92

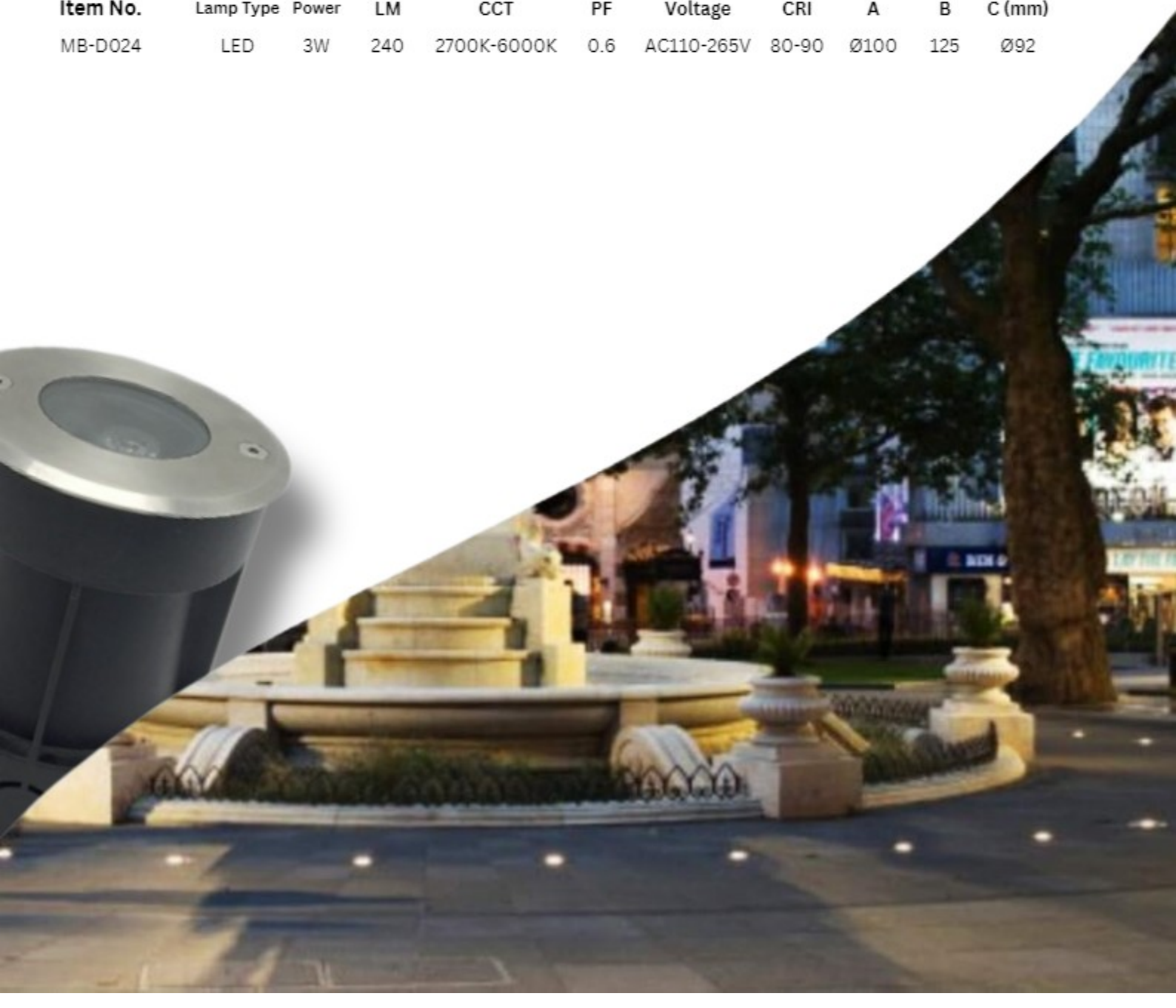

## IN-346-MB-D025

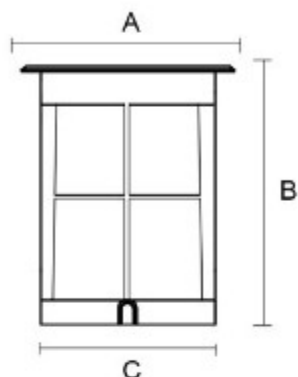

### Product Description

Simple and easy appearance, in line with contemporary aesthetic concept

The lamp body adopts high quality and Anti-UV ability outdoor's polycarbonate;  
High efficiency constant current driver, ensure the light source is maximum used.

**Protection class** : IP67

### Material

Diffuse : Glass

Body : Aluminum+Stainless steel

### Cut Out

ø108\*85mm

Item No.	Lamp Type	Power	LM	CCT	PF	Voltage	CRI	A	B	C (mm)
MB-D025	LED	5W	400	2700K-6000K	0.6	AC110-265V	80-90	Ø120	90	Ø108







# UNDERWATER LIGHT





## UN-346-MB23-0801

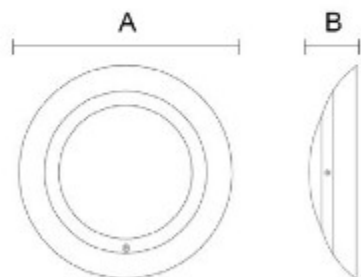

### Product Description

Simple and easy appearance, in line with contemporary aesthetic concept

The lamp body adopts high quality and Anti-UV ability outdoor's polycarbonate;

High efficiency constant current driver, ensure the light source is maximum used.

**Protection class** : IP68

### Material

Diffuse : PC

Body : Plastic

Item No.	Lamp Type	Power	LM	CCT	PF	Voltage	CRI	A	B	C (mm)
MB23-0801230	LED	12W	960	2700K-6000K/RGB	0.6	DC12/DC24V	80-90	Ø230	45	-
MB23-0801295	LED	18W	1440	2700K-6000K/RGB	0.6	DC12/DC24V	80-90	Ø295	45	-



## UN-346-MB23-0802

### Product Description

Simple and easy appearance, in line with contemporary aesthetic concept. The lamp body adopts high quality and Anti-UV ability outdoor's polycarbonate; High efficiency constant current driver, ensure the light source is maximum used.

**Protection class** : IP68

### Material

Diffuse : PC

Body : Plastic

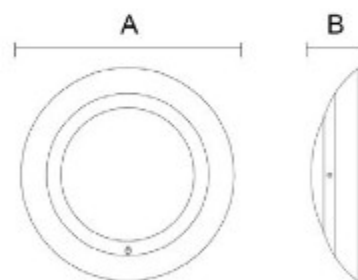

Item No.	Lamp Type	Power	LM	CCT	PF	Voltage	CRI	A	B	C (mm)
MB23-0802230	LED	12W	960	2700K-6000K/RGB	0.6	DC12/DC24V	80-90	Ø230	45	-
MB23-0802295	LED	18W	1440	2700K-6000K/RGB	0.6	DC12/DC24V	80-90	Ø295	45	-

## UN-346-MB23-0803

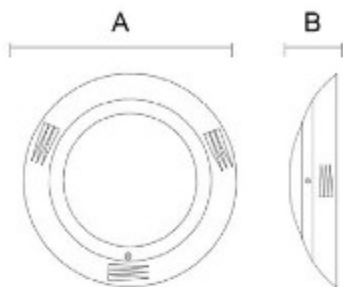

### Product Description

Simple and easy appearance, in line with contemporary aesthetic concept

The lamp body adopts high quality and Anti-UV ability outdoor's polycarbonate; High efficiency constant current driver, ensure the light source is maximum used.

**Protection class** : IP68

### Material

Diffuse : PC

Body : Plastic

Item No.	Lamp Type	Power	LM	CCT	PF	Voltage	CRI	A	B	C (mm)
MB23-0803230	LED	12W	960	2700K-6000K/RGB	0.6	DC12/DC24V	80-90	Ø230	45	-
MB23-0803295	LED	18W	1440	2700K-6000K/RGB	0.6	DC12/DC24V	80-90	Ø295	45	-

## UN-346-MB-2001

### Product Description

Simple and easy appearance, in line with contemporary aesthetic concept. The lamp body adopts high quality and Anti-UV ability outdoor's polycarbonate; High efficiency constant current driver, ensure the light source is maximum used.

**Protection class** : IP68

### Material

Diffuse : PC

Body : Stainless steel+Plastic

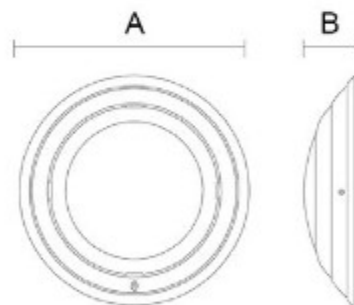

Item No.	Lamp Type	Power	LM	CCT	PF	Voltage	CRI	A	B	C (mm)
MB-2001	LED	18W	1440	2700K-6000K/RGB	0.6	DC12/DC24V	80-90	Ø295	70	-
MB-2002	LED	12W	960	2700K-6000K/RGB	0.6	DC12/DC24V	80-90	Ø230	50	-



## UN-346-MB-2003



MB-2003

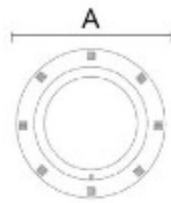

MB-2004

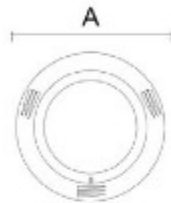

### Product Description

Simple and easy appearance, in line with contemporary aesthetic concept

The lamp body adopts high quality and Anti-UV ability outdoor's polycarbonate;

High efficiency constant current driver, ensure the light source is maximum used.

**Protection class** : IP68

### Material

Diffuse : PC

Body : Plastic

Item No.	Lamp Type	Power	LM	CCT	PF	Voltage	CRI	A	B	C (mm)
MB-2003	LED	18W	1440	2700K-6000K/RGB	0.6	DC12/DC24V	80-90	Ø295	65	-
MB-2004	LED	12W	960	2700K-6000K/RGB	0.6	DC12/DC24V	80-90	Ø265	65	-





## UN-346-MB-2008

### Product Description

Simple and easy appearance, in line with contemporary aesthetic concept. The lamp body adopts high quality and Anti-UV ability outdoor's polycarbonate; High efficiency constant current driver, ensure the light source is maximum used.

**Protection class** : IP68

### Material

Diffuse : Glass

Body : Stainless steel



MB-2008

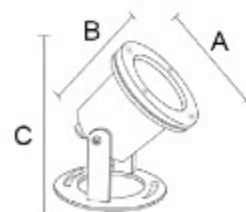

MB-2009

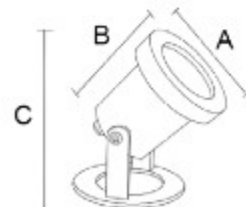

Item No.	Lamp Type	Power	LM	CCT	PF	Voltage	CRI	A	B	C (mm)
MB-2008	LED	3W	240	2700K-6000K/RGB	0.6	DC12/DC24V	80-90	Ø90	70	70
MB-2009	LED	3W	240	2700K-6000K/RGB	0.6	DC12/DC24V	80-90	Ø75	72	60

## UN-346-MB-2013

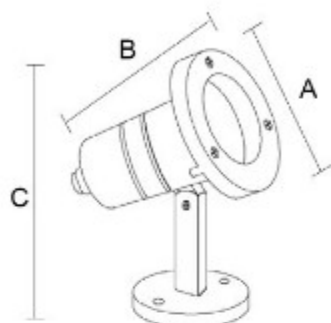

### Product Description

Simple and easy appearance, in line with contemporary aesthetic concept

The lamp body adopts high quality and Anti-UV ability outdoor's polycarbonate;

High efficiency constant current driver, ensure the light source is maximum used.

**Protection class** : IP68

### Material

Diffuse : PC

Body : Stainless steel

Item No.	Lamp Type	Power	LM	CCT	PF	Voltage	CRI	A	B	C (mm)
MB-2013	LED	3W	240	2700K-6000K/RGB	0.6	DC12/DC24V	80-90	Ø82	90	70





## UN-346-MB-2015

### Product Description

Simple and easy appearance, in line with contemporary aesthetic concept. The lamp body adopts high quality and Anti-UV ability outdoor's polycarbonate; High efficiency constant current driver, ensure the light source is maximum used.

**Protection class** : IP68

### Material

Diffuse : Glass

Body : Stainless steel

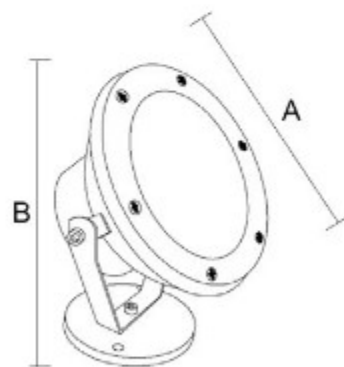

Item No.	Lamp Type	Power	LM	CCT	PF	Voltage	CRI	A	B	C (mm)
MB-2015	LED	6W	480	2700K-6000K/RGB	0.6	DC12/DC24V	80-90	Ø120	140	-
MB-2016	LED	9W	720	2700K-6000K/RGB	0.6	DC12/DC24V	80-90	Ø145	180	-
MB-2031	LED	12W	960	2700K-6000K/RGB	0.6	DC12/DC24V	80-90	Ø160	190	-



## UN-346-MB-G110

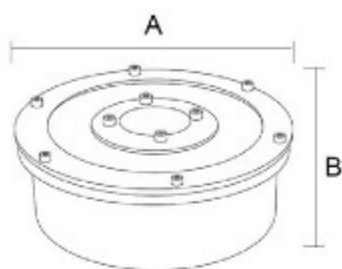

### Product Description

Simple and easy appearance, in line with contemporary aesthetic concept

The lamp body adopts high quality and Anti-UV ability outdoor's polycarbonate;

High efficiency constant current driver, ensure the light source is maximum used.

**Protection class** : IP68

### Material

Diffuse : Glass

Body : Stainless steel

Item No.	Lamp Type	Power	LM	CCT	PF	Voltage	CRI	A	B	C (mm)
MB-G110	LED	6W	480	2700K-6000K/RGB	0.6	DC12/DC24V	80-90	Ø110	31	70
MB-G130	LED	6W	480	2700K-6000K/RGB	0.6	DC12/DC24V	80-90	Ø130	38	80
MB-G160	LED	9W	720	2700K-6000K/RGB	0.6	DC12/DC24V	80-90	Ø160	38	85
MB-G180	LED	12W	960	2700K-6000K/RGB	0.6	DC12/DC24V	80-90	Ø180	50	85
MB-G200	LED	18W	1620	2700K-6000K/RGB	0.6	DC12/DC24V	80-90	Ø200	60	85





# UNDERWATER LIGHT





# CONTACT



086-945-8988  
093-579-9471



Artisanlighting.net  
โคมไฟสั่งทำ นำเข้า รับซ่อม คุณภาพดี  
LAMP SHOP PHUKET



[www.artisanlighting.net](http://www.artisanlighting.net)



@artisanlighting



100/364-5 M.5 PRACHA U THIT RD.,  
PHUKET, THAILAND

