

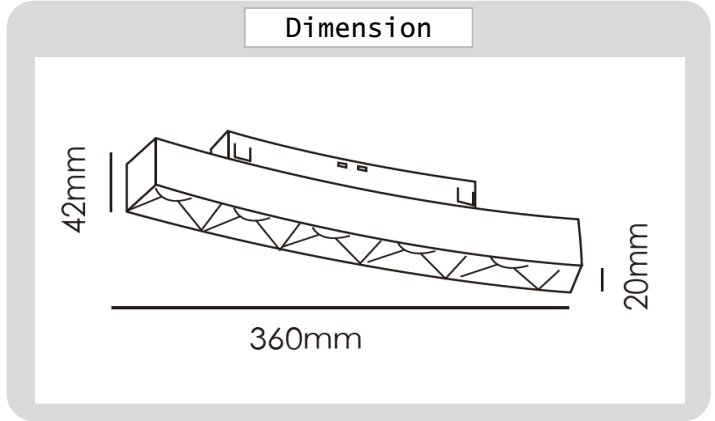

Project : _____
Approve : _____

**Product
Specification**

Product



Specification

PRODUCT CODE	: MG-321-C20YG360
NAME	: MAGNETIC TRACK LIGHT
BRAND	: ARTISAN LIGHTING PHUKET
MATERIAL	: DIE-CAST ALUMINUM
FINISHING	: SAND BLACK
INPUT VOLTAGE	: DC 48V
LAMP TYPE	: LED BUILD IN CREE
POWER	: 15W
CCT	: 2700K,3000k, 4000K
BEAM ANGLE	: 30D
CRI RATING	: CRI 90
LUMEN	: 1376Lm
DIMENSION	: 42x360x20 mm.
DIMMABLE	: NO, 0-10V, DALI, OPTIONAL
REMARK	:

Artisan Lighting Phuket Co., Ltd.

100/364-5 Moo.5 Pracha-U-Thid Rd., Rassada, Muang, Phuket 83000 Thailand. Tel : (+66) 076 376 101
Mobile & Line ID : 086 945 8988, 093 579 9471, Email : support@artisanlighting.net, www.artisanlighting.net