



Product Specification

LED Square underground light

- Power: 3W
- Luminous flux: 180Lm
- CRI : >80Ra
- LED Brand: CREE-XBD LED
- Input voltage: DC12V-24V
- Beam angle: 45°
- Color temperature options: warm white (2700-3000K), neutral white (4000-4500K), cool white (6000-6500K)
- Other light color options: red, green, blue
- Ingress Protection: IP68
- Light body material: surface ring (304 stainless steel), the main (6063 aluminum)
- Service life: 35000 hours



Product Specifications:

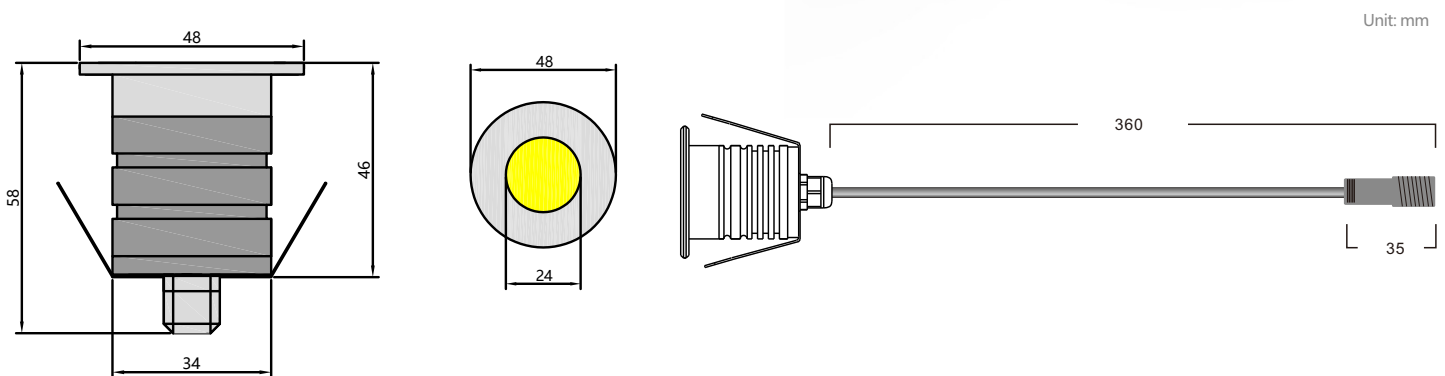

Product Features:

- ◆ Independent research and development, private-mode products, uncompromising attention, light body compact, flexible wide range of applications;
- ◆ light color rich optional, warm white, sun white, cold white, red, green, blue and other light;
- ◆ can be monochrome dimming;
- ◆ Protection class IP67, can be used in 10 meters underwater;
- ◆ The main surface can withstand pressure up to 300KG or more;
- ◆ Light body with 304 stainless steel surface ring, with corrosion-resistant, high temperature, never change color, real durable;
- ◆ Low-voltage input voltage, safe and reliable;

Applications:

Swimming pool, road, square, sidewalk, garden floor, building exterior, Bridges and other outdoor places, due to super waterproof function, and can be applied to ships and yachts



Detailed description:

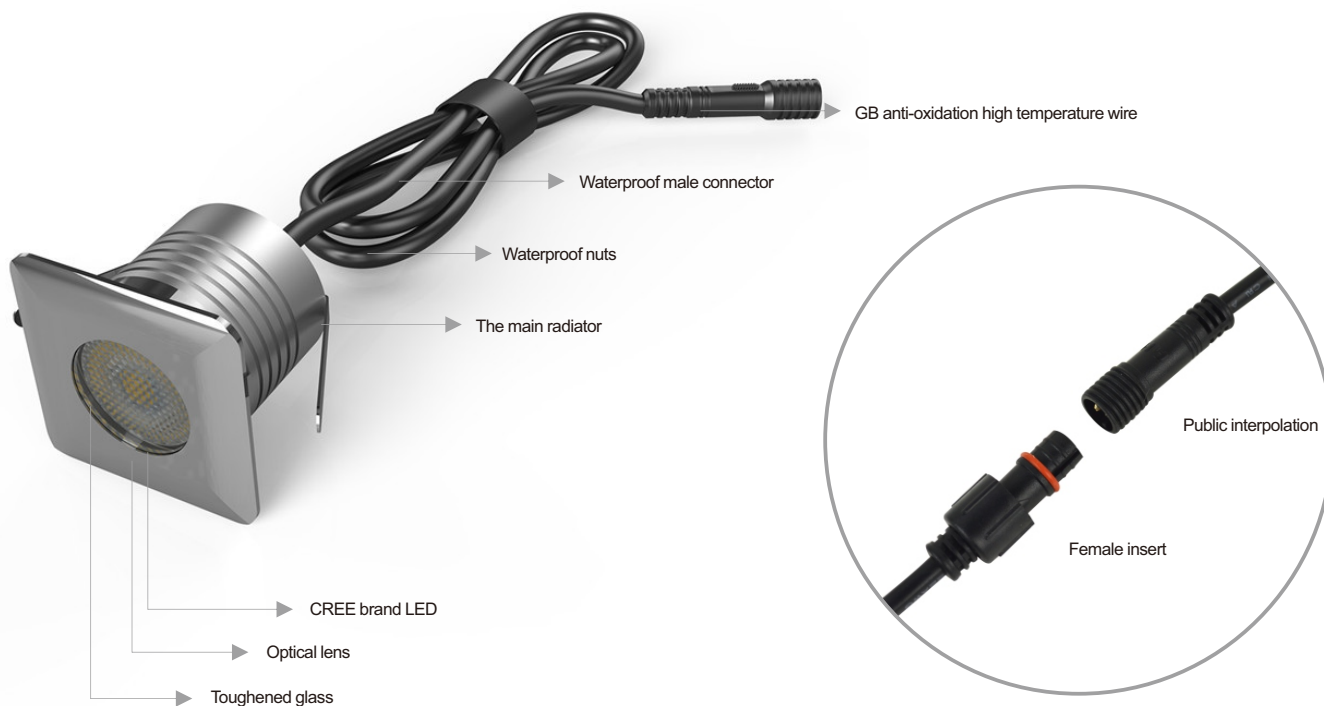

Use the installation method

method 1:

Flooring / Marble / Tile panels

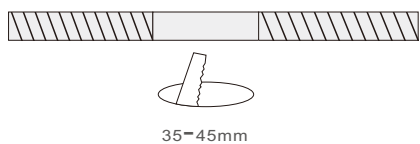

Embedded installation

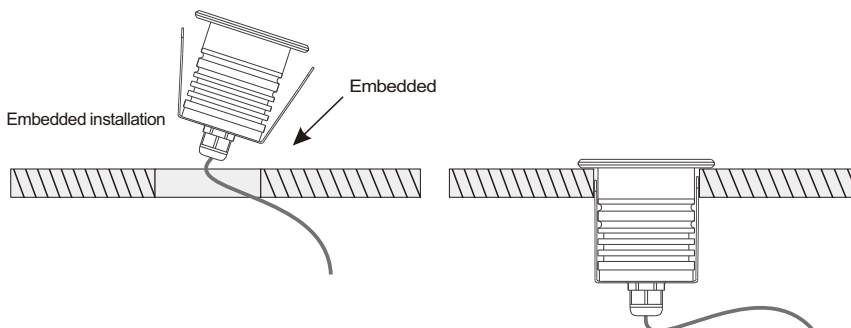

Method 2:

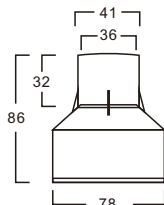

Wiring, fixed embedded parts

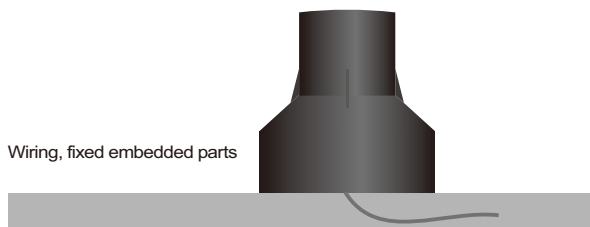

Filled with cement

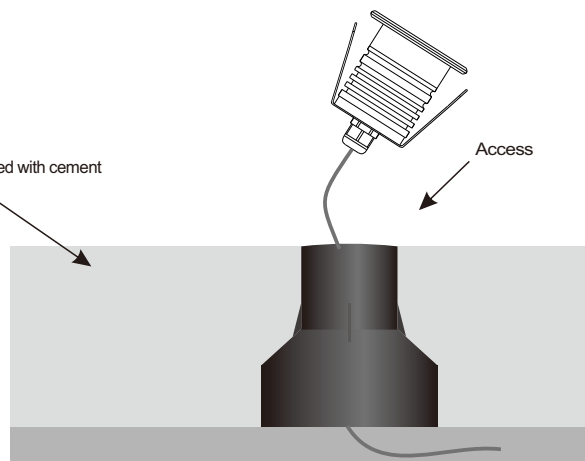

Wiring installation (parallel type):

Access DC / AC12V or DC24V, can be used in the market common constant voltage transformer, the project is simple to install.

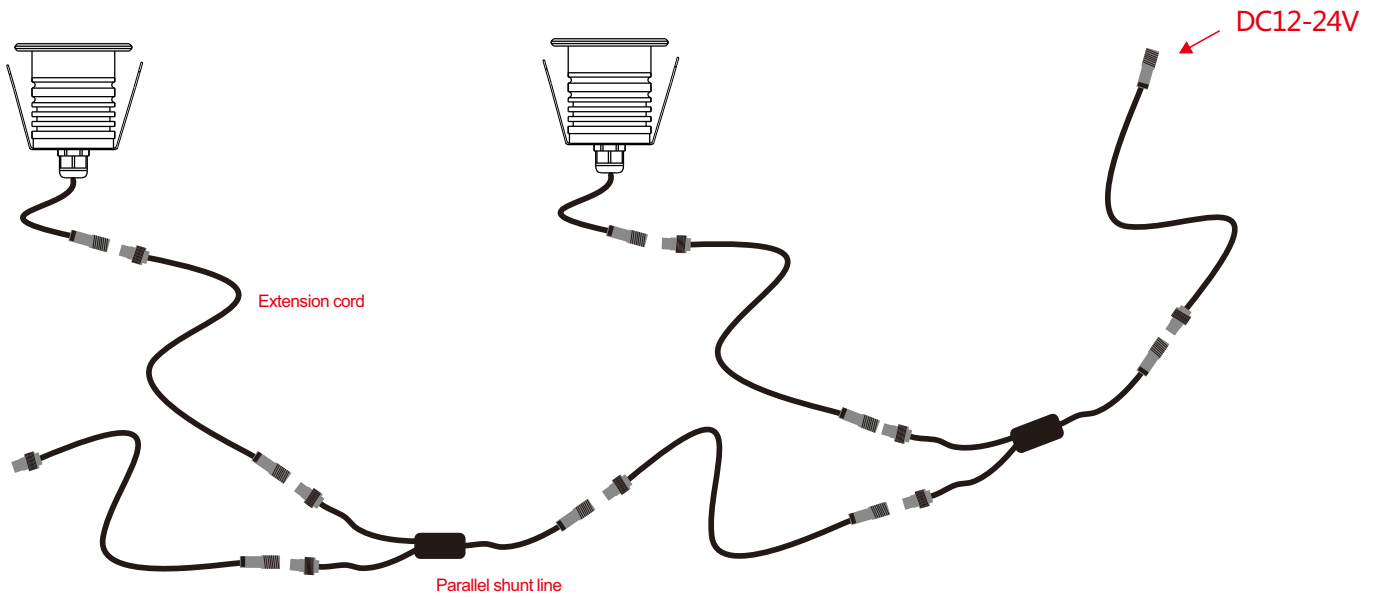

The following brands of power supplies can be customized.
One power supply can carry 10 lights

