

Product

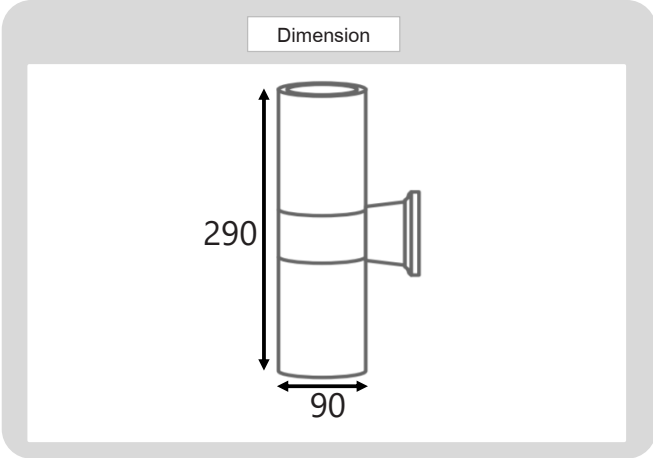

Specification

PRODUCT DETAILS

PRODUCT CODE	:	WA-068-104
NAME	:	WALL LAMP OUTDOOR
BRAND	:	ARISAN LIGHTING PHUKET
MATERIAL	:	ALUMINUM DIE-CAST, GLASS
FINISHING	:	POWDER COATED BLACK
ADJUSTABLE	:	NO
DIMENSION	:	D90 X H290 mm.
LAMP TYPE OPTION	:	E27 X 2
IP RATING	:	IP65
REMARK	:	LED BULB NOT INCLUDED