

Product

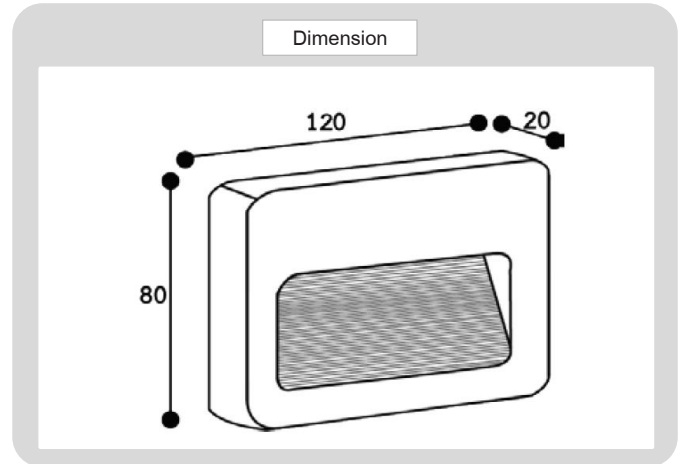

Specification

HOUSING DETAILS

PRODUCT CODE	:	STEP-068-5325-2W
NAME	:	STEPLIGHT OUTDOOR
BRAND	:	ARTISAN LIGHTING PHUKET
MATERIAL	:	ALUMINIUM
FINISHING	:	BLACK, WHITE
DIMENSION	:	80 X 120 X 20 mm
MOUNTING DETAILS	:	SURFACE MOUNTING

LIGHT SOURCE

LAMP TYPE	:	LED SMD 2W BUILD-IN
INPUT VOLTAGE	:	AC100-240V
POWER	:	2W
COLOR TEMPERATURE CCT	:	3000K
LUMEN	:	140lm
CRI	:	80
IP RATING	:	IP65
LIFE TIME	:	30,000 Hrs

CONTROL INTERFACE

CONTROL GEAR	:	ON-OFF LED DRIVER BUILD-IN
DIMMABLE MODE OPTIONAL	:	NON
REMARK	:	

Artisan Lighting Phuket Co.,Ltd.

100/364-5 Moo.5 Pracha-U-Thid Rd., Rassada, Muang, Phuket 83000 Thailand. Tel : (+66) 076 376 101

Mobile & Line ID : 086 945 8988, 093 579 9471 Email : support@artisanlighting.net, www.artisanlighting.net